

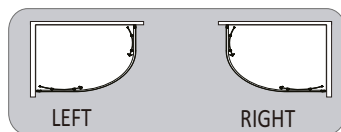

LM-902L 120x80x215cm

LM-902R 120x80x215cm

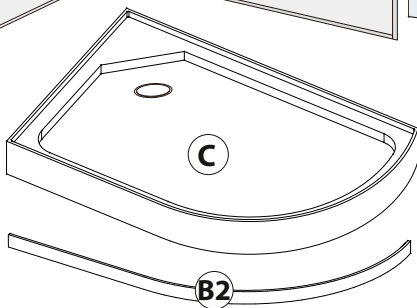

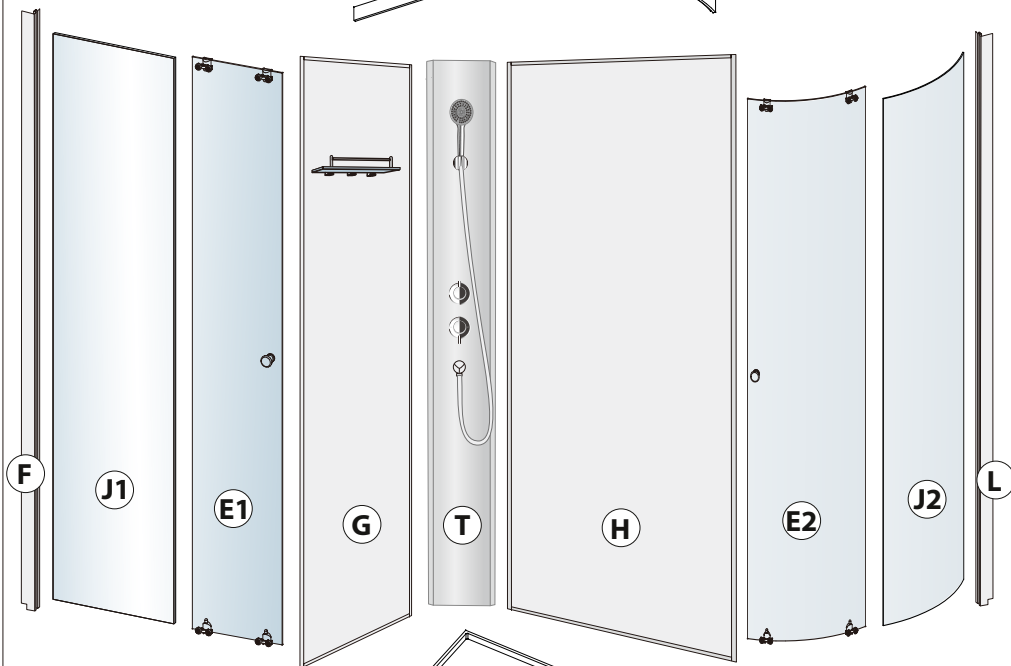
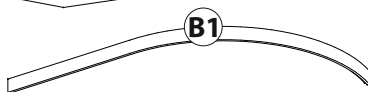
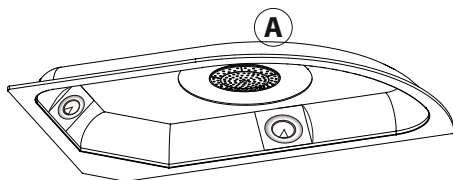

H1



1820mm
x2

H2

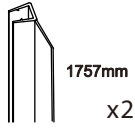

1757mm
x2

H3



x8

H4



x2

H5



x4

H6

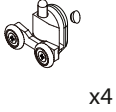

x4

H7

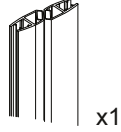

x1

H8

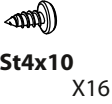

St4x10
x16

H9



x1

H10



M4x25
x2

H11



St4x30
x8

H12



x4

H13



St4x12
x4

H14

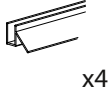

x4

H15



St4x12
x8

H16

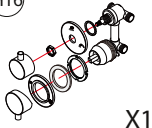

x1

H17

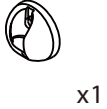

x1

H18



x2

H19

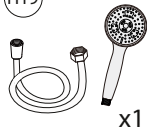

x1

H21

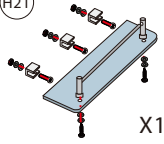

x1

H22

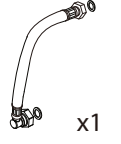

x1

H23

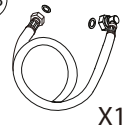

x1

H24



x2

H25

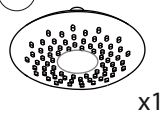

x1

H35

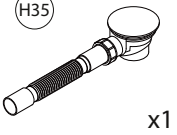

x1

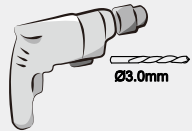
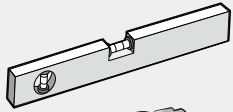
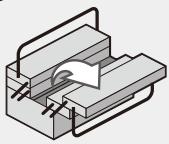

Ø3.0mm

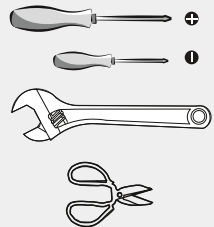

1

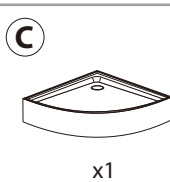
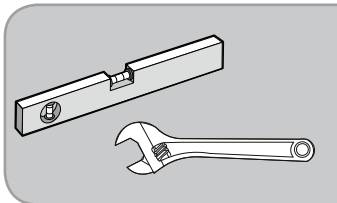
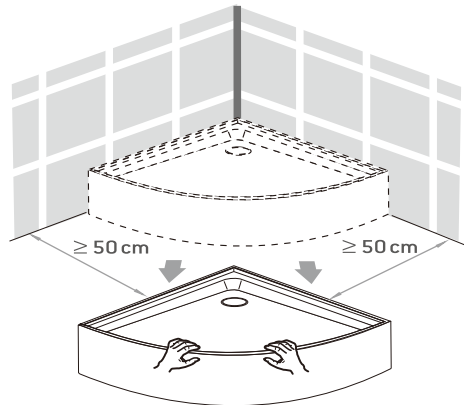
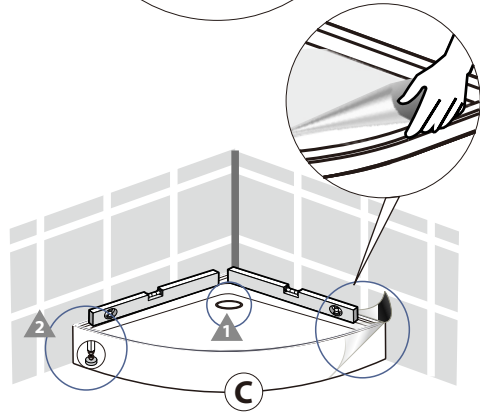
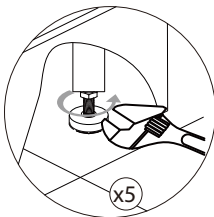
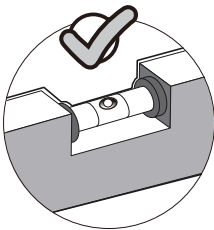
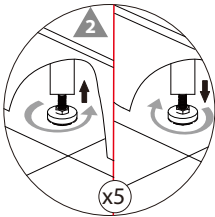
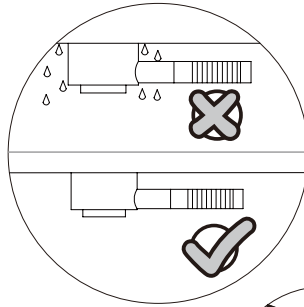
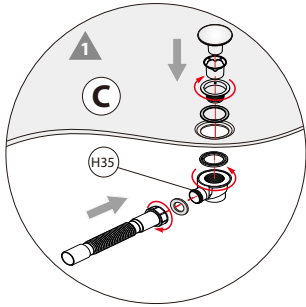

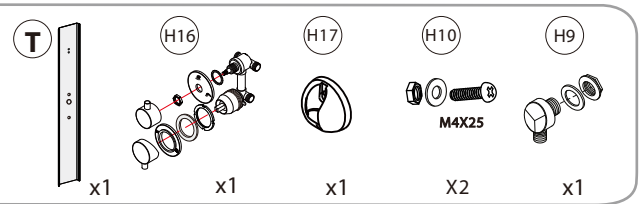
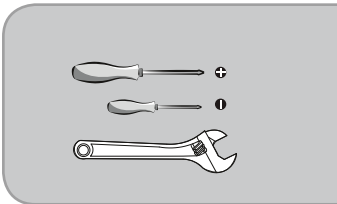
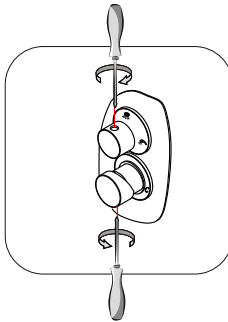
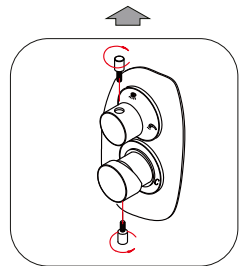
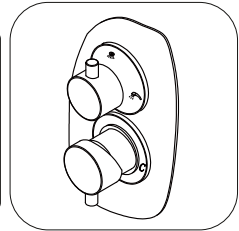
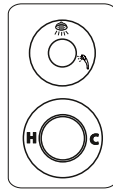
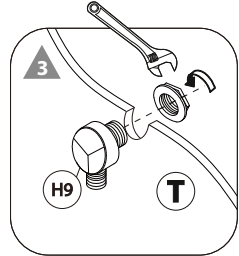
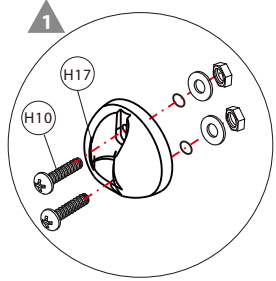
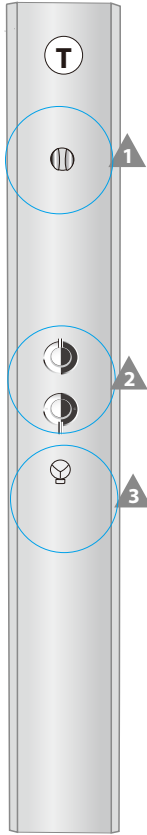
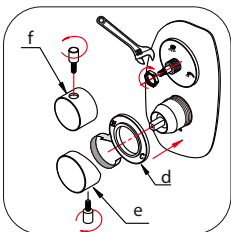
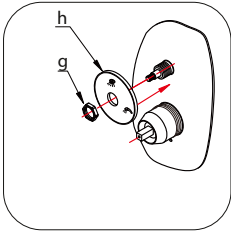
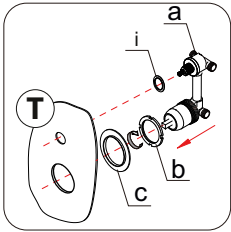
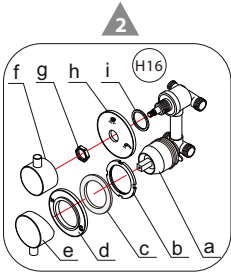

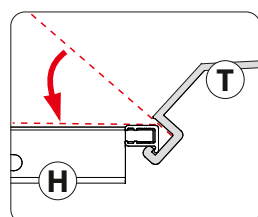
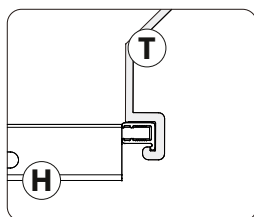
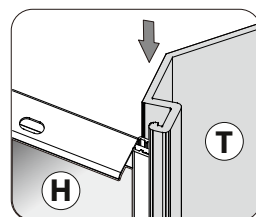
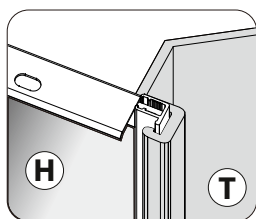
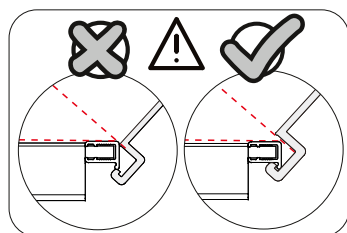
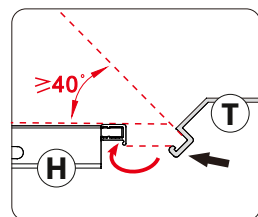
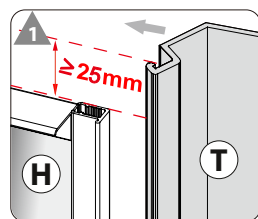
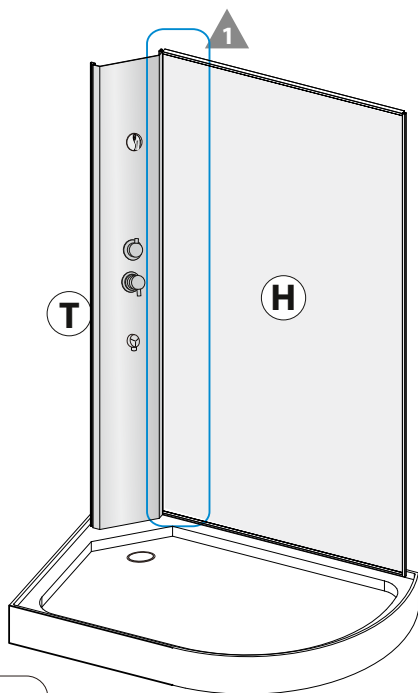

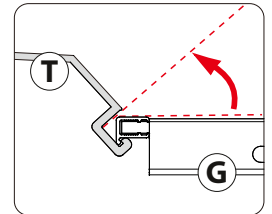
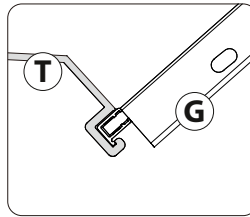
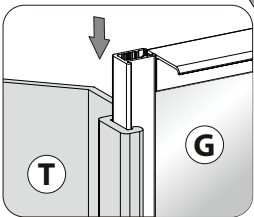
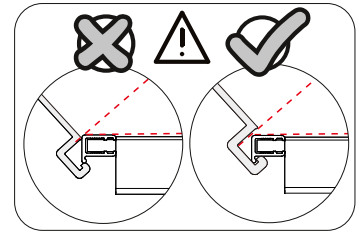
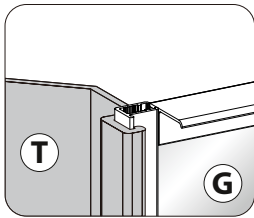
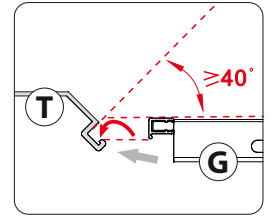
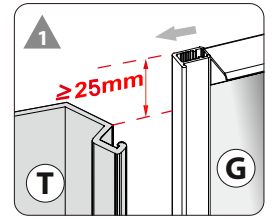
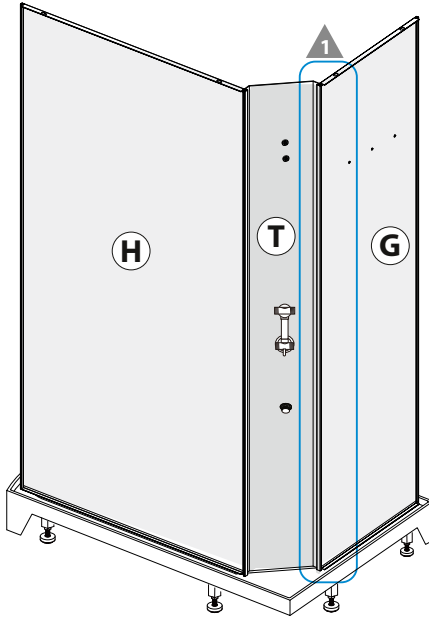

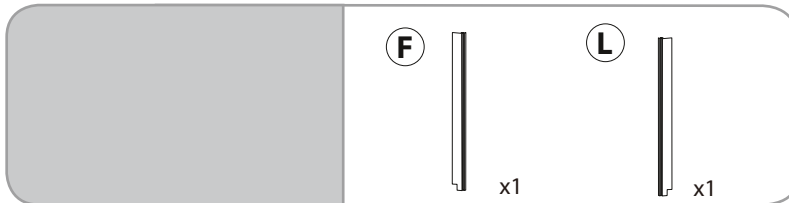
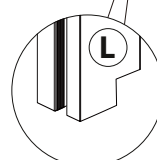
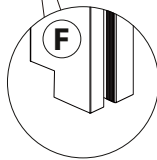
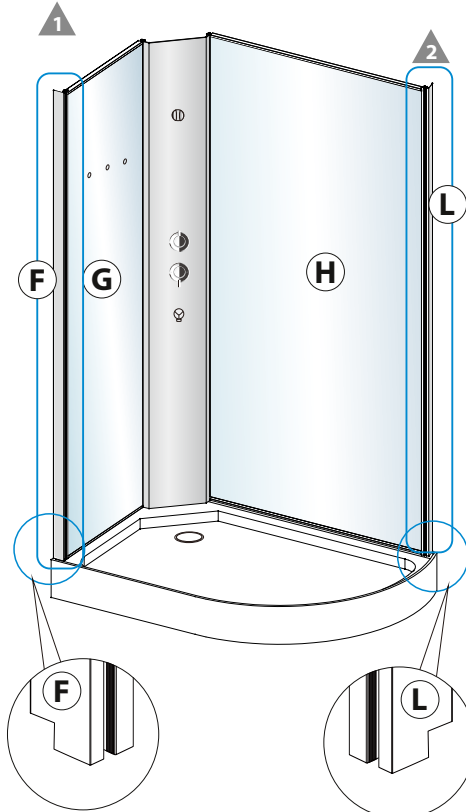
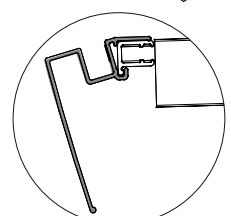
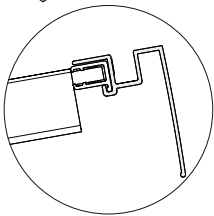
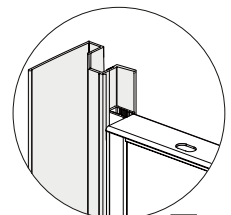
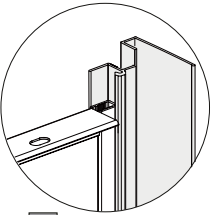
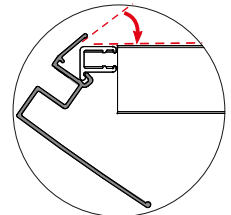
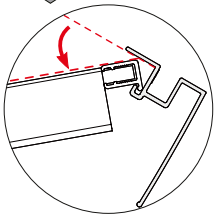
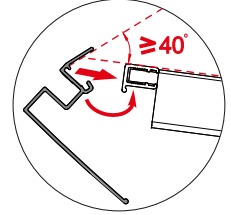
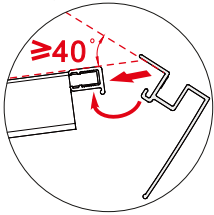
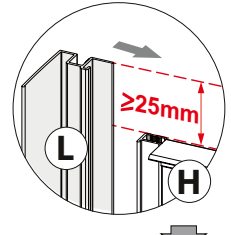
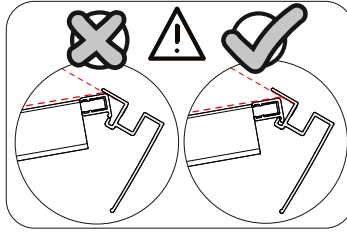
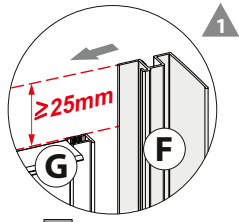

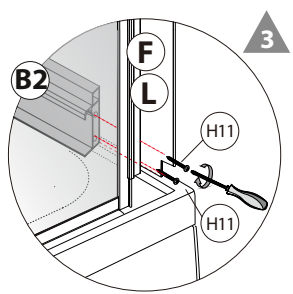
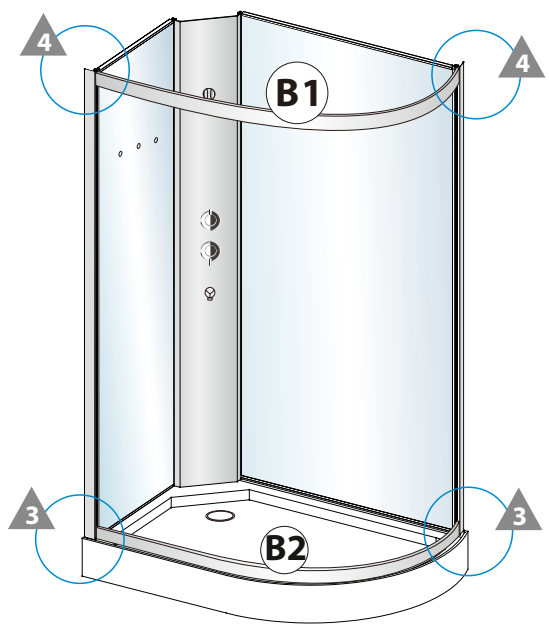
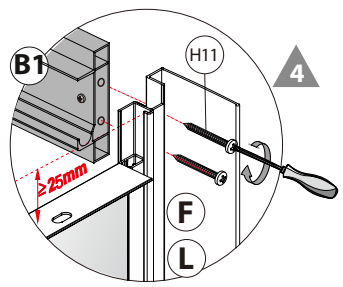
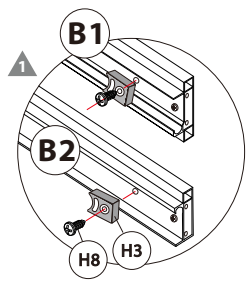
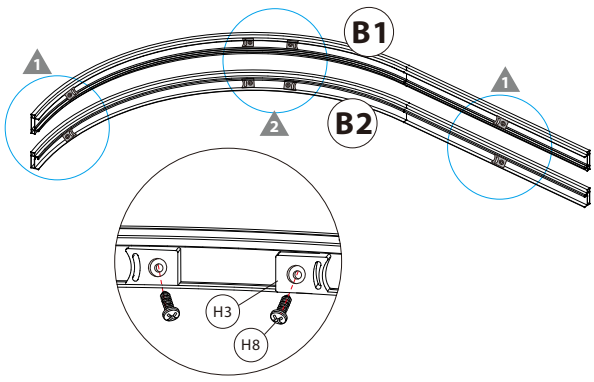

--	--	--	--	--

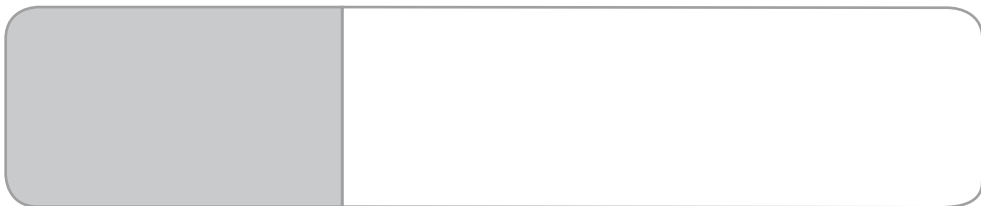
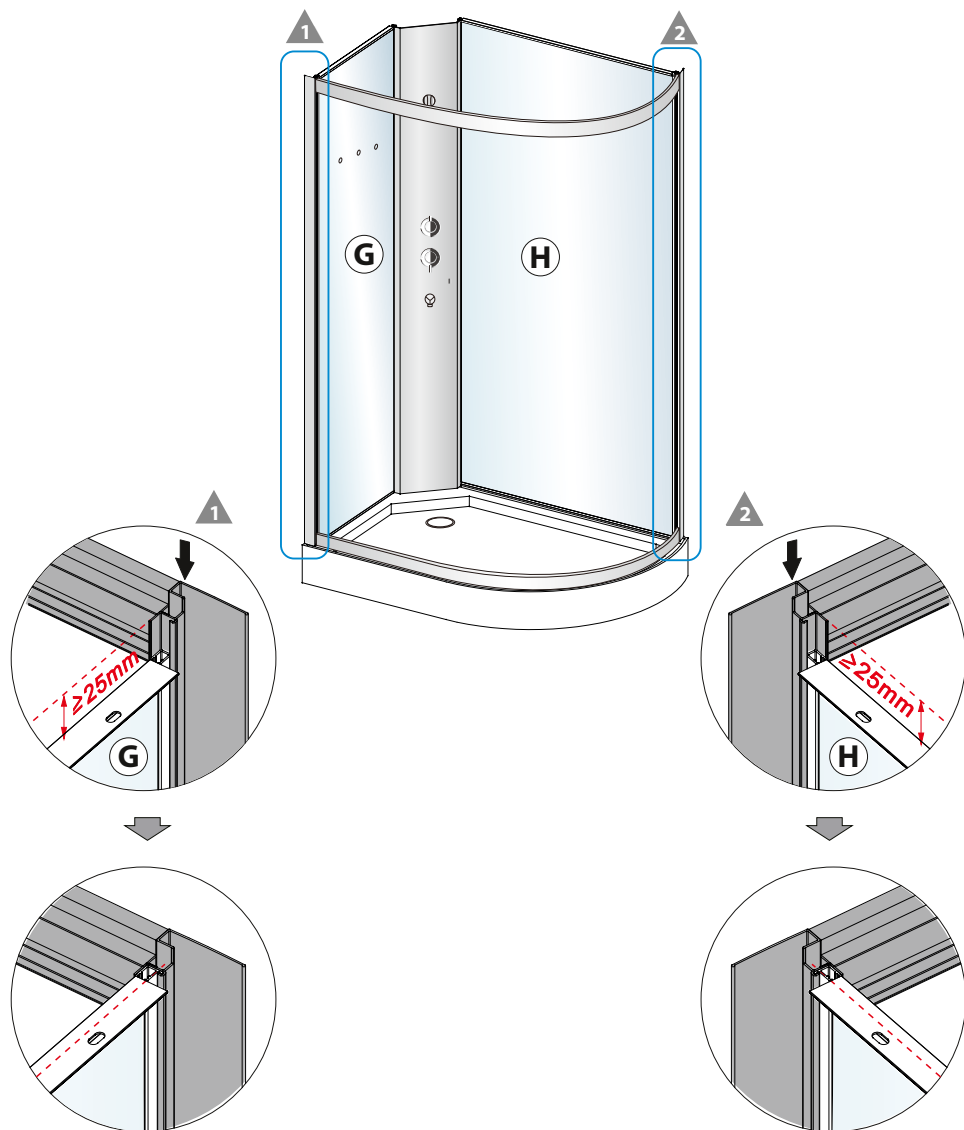

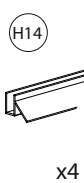
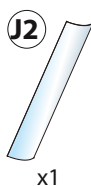
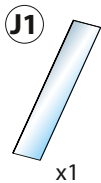
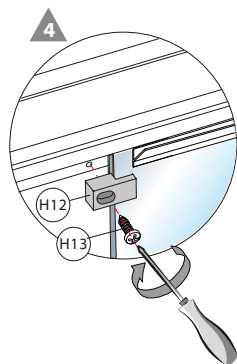
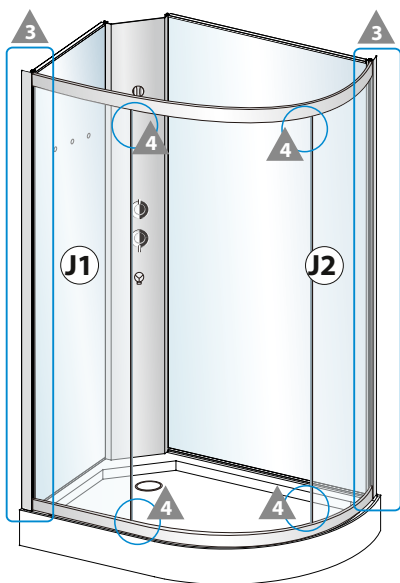
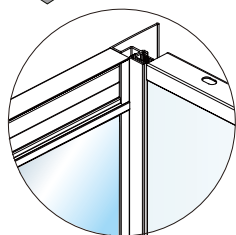
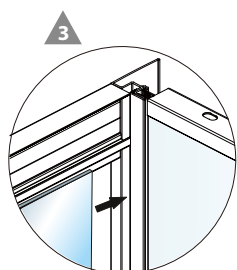
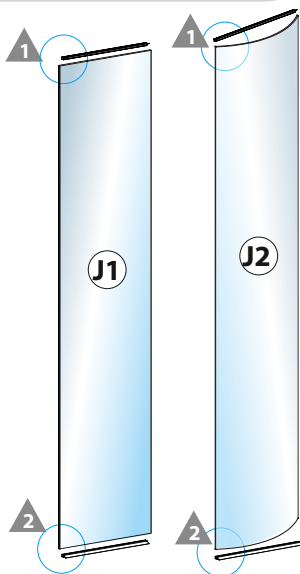
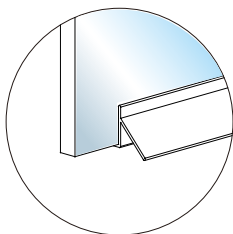
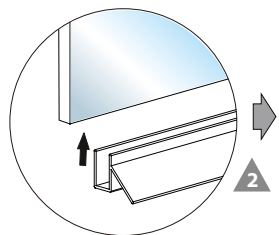
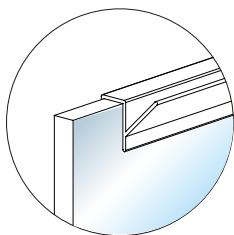
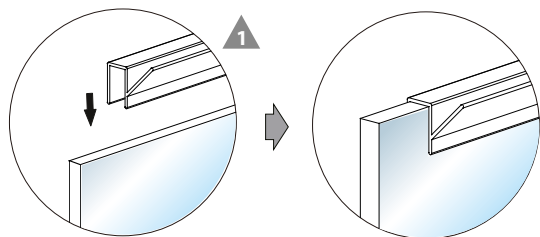

St4X12

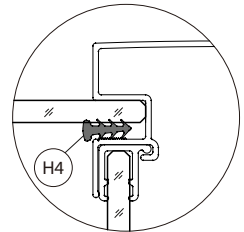
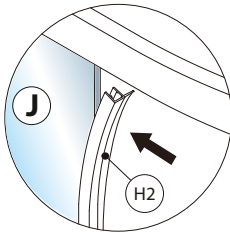
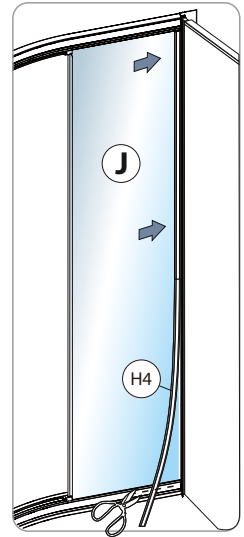
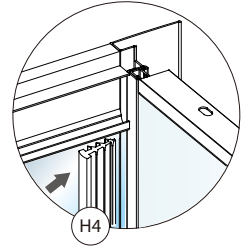
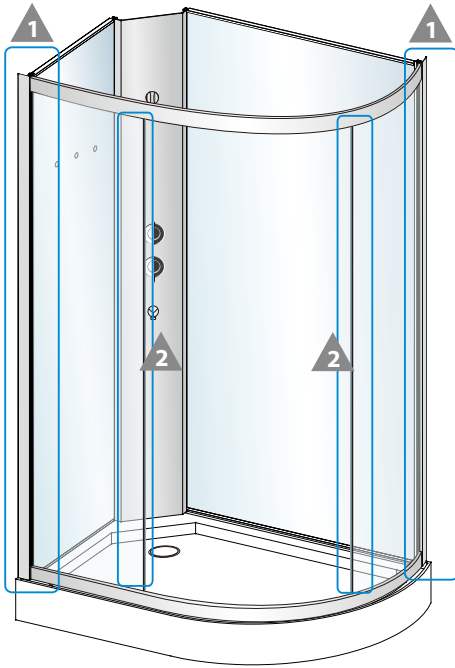

H4



X2

H2



X2

2

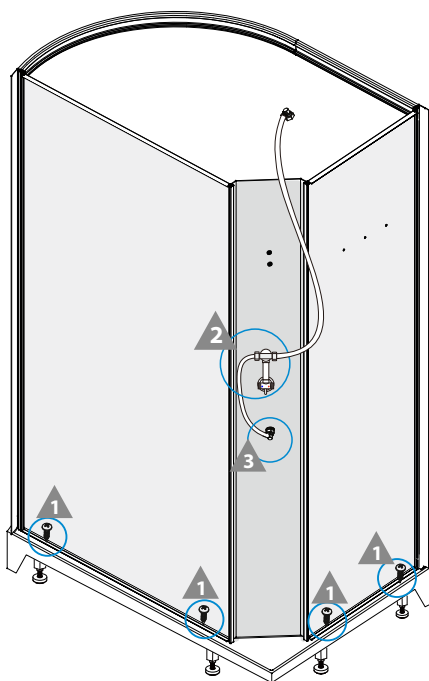
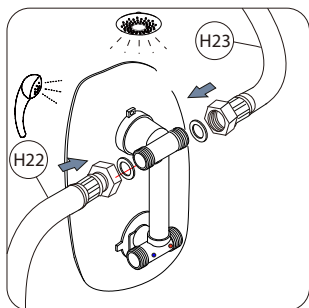

3

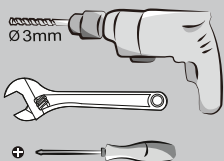
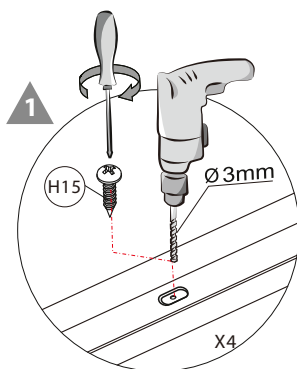
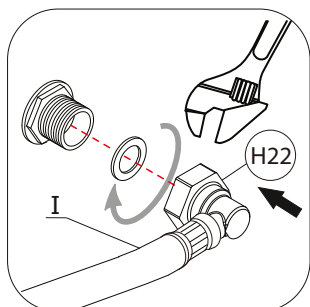

H15
 St4x12
 x4

H22
 x1

H23
 x1

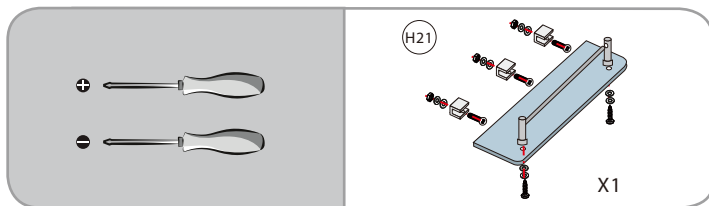
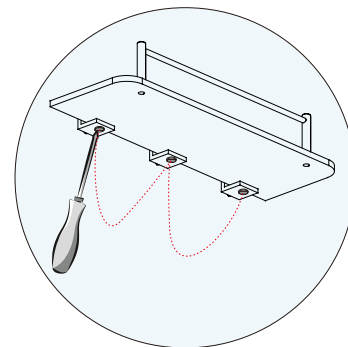
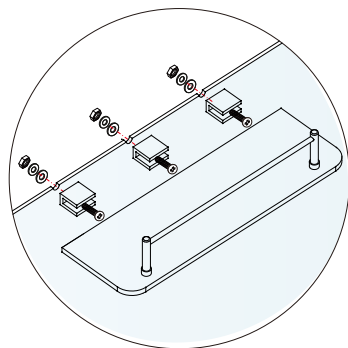
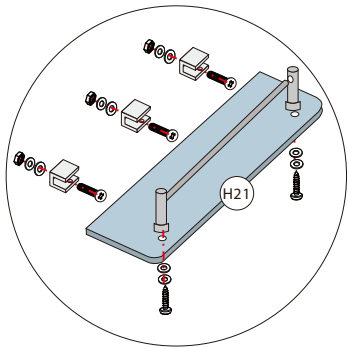

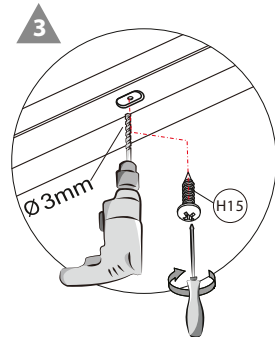
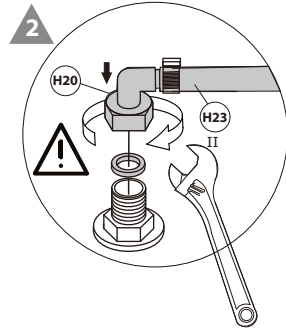
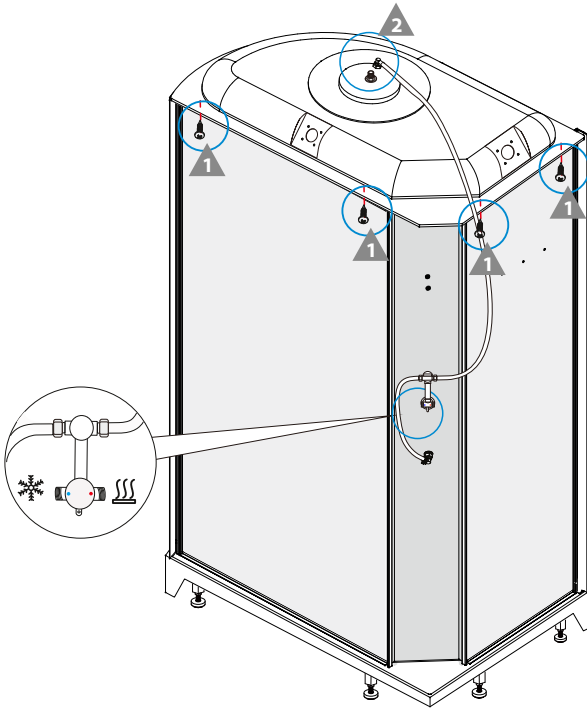
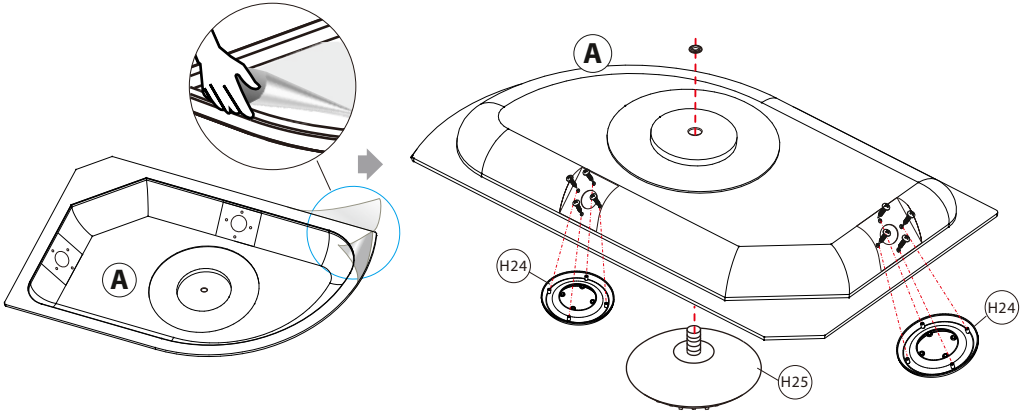

	<p>A</p> <p>x1</p>	<p>H8</p> <p>St4x10</p> <p>X8</p>	<p>H24</p> <p>x2</p>	<p>H25</p> <p>x1</p>	<p>H15</p> <p>St4X12</p> <p>X4</p>
--	---------------------------	---	-----------------------------	-----------------------------	--

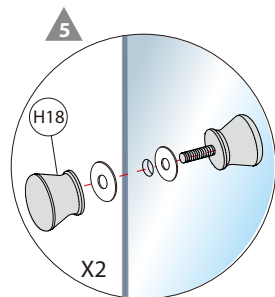
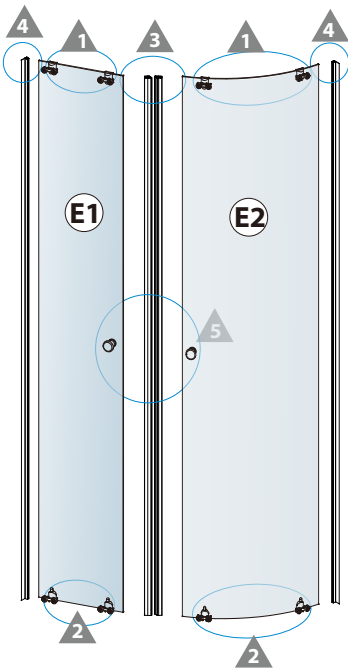
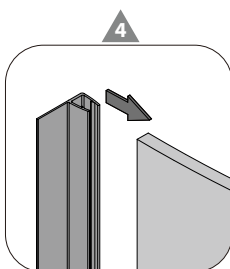
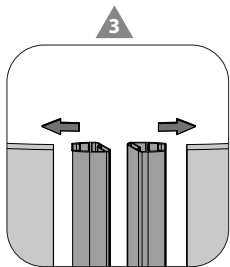
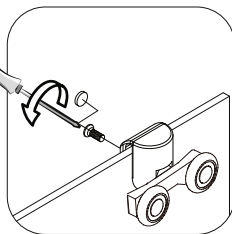
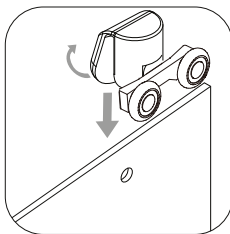
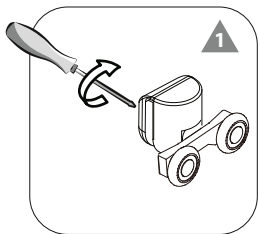

2

